

# SOUND FRIDGE

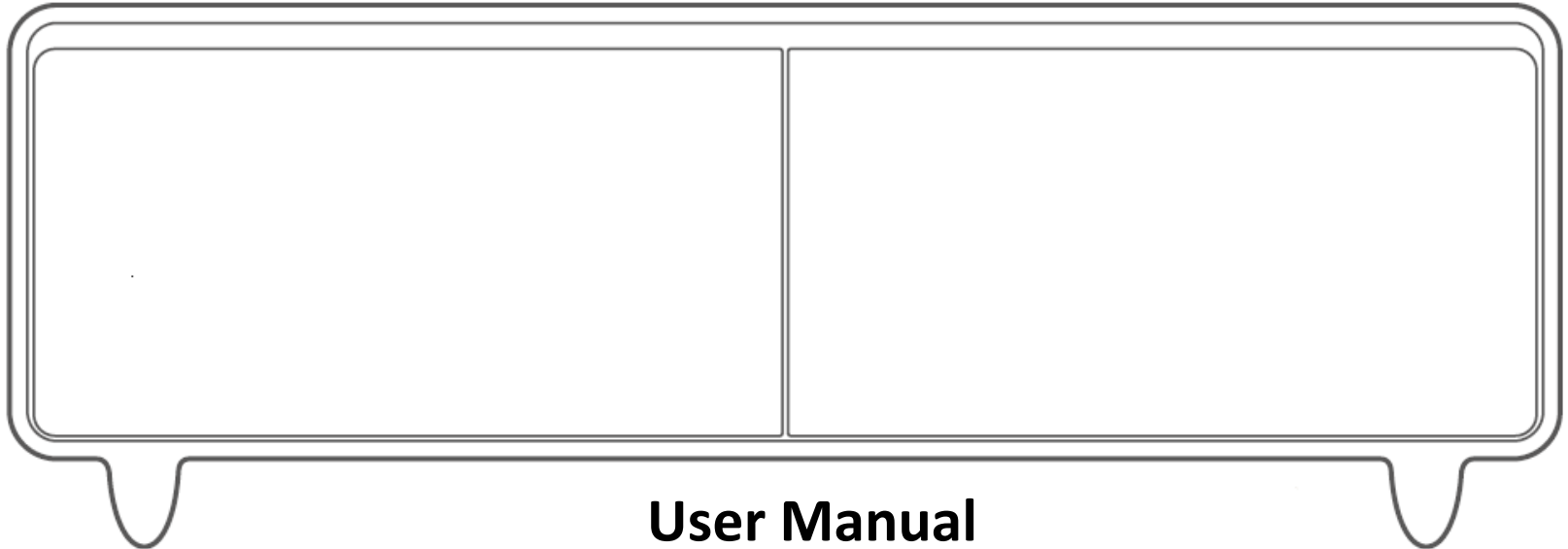

## REFRIGERATED COFFEE TABLE WITH BT SPEAKER & WIRELESS CHARGING



### User Manual Model CT51-FRIDGE-BK



#### **WARNING**

READ UNPACKING INSTRUCTIONS CAREFULLY. YOU MUST LEAVE THE SOUND FRIDGE SITTING TOPSIDE UP FOR A MINIMUM OF 2 HOURS PRIOR TO PLUGGING IN AND TURNING IT ON. DO NOT PLACE THE SOUND FRIDGE UPSIDE DOWN, ON EITHER END OR ANY SIDES.



#### **WARNING**

THOROUGHLY READ ALL INSTRUCTIONS AND WARNINGS PRIOR TO FIRST USE. FAILURE TO DO SO MAY RESULT IN DAMAGE TO THE UNIT, PERSONAL INJURY AND/OR PROPERTY DAMAGE.

# TABLE OF CONTENTS & SPECIFICATIONS

## TABLE OF CONTENTS

- Unpacking the Sound Fridge
- Safety Precautions & Warnings
- Features
- Parts List
- Control Panel
- Fridge Operation
- Speaker Operation
- Charging Functions
- Daily Maintenance
- Transporting the Sound Fridge
- Trouble Shooting
- Warranty

## SPECIFICATIONS

<b>Consumption</b>	0.38KWh/24h	<b>Packing Size</b>	53.5" x 30.5" x 20"
<b>Noise Level</b>	36dB	<b>Temp Control</b>	Electric
<b>Voltage</b>	220V/50Hz/60Hz	<b>Cooling Type</b>	Compressor
<b>Net Weight</b>	135 lbs	<b>Refrigerant/Wt</b>	R600a/21g
<b>Gross Weight</b>	150 lbs	<b>Volume</b>	70L + 65L
<b>Controlling</b>	Electric	<b>Drawer 1 Temp Range</b>	37.4°- 46.4°
<b>Size</b>	51" x 28" x 18.25"	<b>Drawer 2 Temp Range</b>	42.8°- 53.6°
<b>Wireless Charger</b>	15W	<b>USB/Type C</b>	5V/2.1A
<b>Speaker</b>	Bluetooth	<b>Speaker Watts</b>	20W x 2

## PREPARATION FOR USE – UNPACKING

1. Remove all packaging materials.

### **WARNING**

Remove from foam base. Do not use while on foam base. Doing so may result in personal injury and/or property damage.

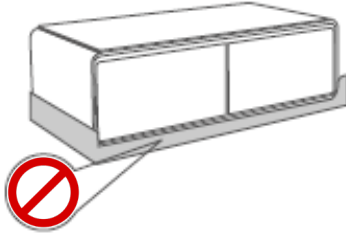

2. Peel off transparent film from surface of the table.
3. Ensure all accessories are included.

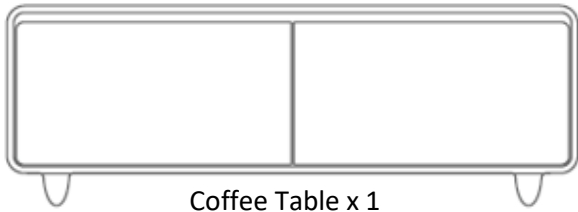

Coffee Table x 1



Manual x 1



Partitions x 4



Trays x 2

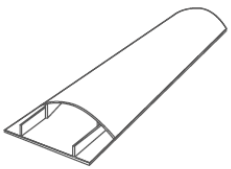

Cable Cover x 1

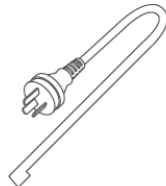

Power Cable x 1

4. Place table where it will be hooked up.

### **WARNING**

- Place table so that there is more than 16-inches on the front side (speaker side) and at least 20-inches on the back side (furniture side).

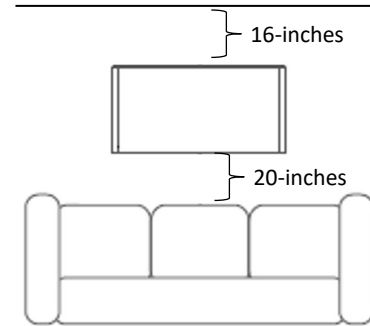

- Table should be on flat, solid surface.

5. Clean the unit before using (Refer to Maintenance Instructions).
6. **Do NOT connect the power cord to power source. Let unit sit for 2 hours.**
7. After 2 hours, it is ready to be plugged in and powered on.

### **WARNING**





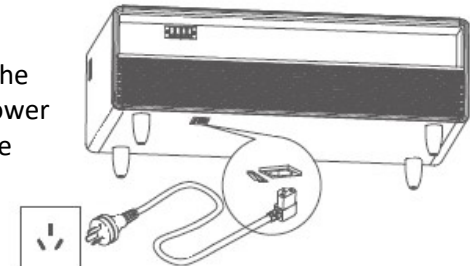

Total external electrical home appliances should not exceed 2200W. Do not use an external patch.

### **WARNING**

There is overload protection on the bottom of the unit. If the total power consumption exceeds 2200W, the power supply will cut off automatically.



## ELECTRICAL WARNINGS

-  Before initially powering on the unit, please install the cable cover to prevent any damage of the cable.
-  The power cord should be kept in firm contact with the power source. Failure to do so could result in property damage, personal injury and/or fire.
-  To avoid damage to the cable, please do not step on the cable.
-  Do not roll over the power cord when moving the Sound Fridge.
-  When unplugging the Sound Fridge, do not pull on the cable. Firmly grasp the plug to remove from power source.
-  Before cleaning, repairing or replacing any parts, unplug the Sound Fridge to avoid electric shock.
-  If the power cable or plug has any damage, do not use.

## POWER SUPPLY WARNING

-  Sound Fridge should be powered by AC 110V. If the voltage fluctuation is out of range, it may cause unit failure, property damage and/or personal injury.

## GROUNDING WARNING

-  Independent power source should be used and be grounded. Sound Fridge power cable is equipped with grounded plug and socket. Never remove or cut off the third pin.

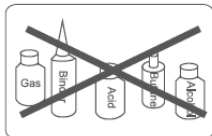



## WARNING!

No repairs or modifications shall be made to the Sound Fridge. Failure to adhere to this warning may result in property damage, personal injury and/or death.



NOTE: New refrigerant type R600a must be repaired by a trained professional. Fire may occur during repair, if not handled properly. Damaged units should be recycled by a professional company or as detailed by the State of residence.



## STORAGE WARNINGS

-  Sound Fridge should not be used to store blood or other biological products.
-  Sound Fridge should not be used to store any products that are inflammable, explosive or dangerous, as well as any chemicals.

## WIRELESS CHARGER

- If the device is equipped with a thick, protective shell, a metal protective shell or a battery shell, the charging efficiency may be affected. Remove shell and try again.
-  The wireless charger may generate heat when charging. If the battery overheats, the software may limit the charging. It will begin charging once the temperature drops.
- When the wireless charger is in use, the USB charging should not be utilized. When using the USB charging, wireless charger should not be used.



## 110 POWER SUPPLY

-  • Keep liquids away from socket. Do not use wet cloth to clean. Water is a conductor, contact with the socket may lead to property damage, personal injury, including electric shock.
-  • The rated power of connected appliance cannot exceed 2000W. Overloading will lead to over-heating and can cause property damage and/or personal injury.
-  • Do not use an external patch.

## USB





-  • Keep liquids away from USB ports. Do not use wet cloth to clean the ports.

## SPEAKER

-  • Sound Fridge should not be in contact with equipment that is damp, hot or has a strong magnetic or electric current. If damage occurs, disengage the Sound Fridge from power supply and remove those items before powering back up.
-  • Use only on a horizontal and stable surface with good ventilation.

## ENVIRONMENT

-  • Sound Fridge should be placed far away from any heat source and out of direct sunlight.
- Sound Fridge should be placed in a well-ventilated area, with at least 16-inches around all sides.
- Do not place the Sound Fridge in areas that are damp or where the unit may encounter water.

-  • Do not place power sockets, regulated power supplies or small appliances on the Sound Fridge.
- Do not put unstable objects on the Sound Fridge to avoid damage to top.
-  • Use caution when placing objects with liquid on table. Spilling liquid can result in property damage, personal injury and/or electric shock.
-  • Do not store gas or any other flammable materials in or near the Sound Fridge to avoid possible fire hazard.
-  • If there is any gas or other flammable material leak around the unit. Close the gas valve and open all doors, and windows immediately. **DO NOT PULL OR TOUCH THE SOUND FRIDGE UNTIL AREA IS CLEAR.**



**WARNING!**  
Do not use Sound Fridge if it has been subjected to any shock or damage. Do NOT attempt to repair the Sound Fridge. Repairing or modifying your Sound Table may result in property damage, fire, personal injury and/or death.

## REFRIGERATED DRAWERS

The Sound Fridge is designed with two refrigerated drawers that can be independently controlled for two zones of temperatures. Both drawers come with partitions and trays to organize all your favorite beverages and snacks.

NOTE:

- Only store fresh food in the Sound Fridge.
- Do not store foods that require colder environments.
- Do not put hot food into the Sound Fridge, as it will increase the temperature inside the unit, affecting items.
- Do not open the drawers frequently or leave them open as it will also cause the temperature to rise.
- Make sure items are securely sealed to avoid excess moisture. This will help keep your Sound Fridge clean and free of odors.

## HIGH EFFICIENCY COMPRESSOR

The Sound Fridge is equipped with a high efficiency compressor to keep your unit working at optimum performance.

## 110V POWER SOCKETS

The Sound Fridge is equipped with 110V power sockets, to supply power to other devices. The power sockets have a separate safety switch to detect high input or overload. If the safety switch detects either, it will cut off power.

## CHARGERS

There are three types of chargers, one 15W wireless charger located on the top, two USB Type A chargers and one USB Type C charger which are located on the side.

## BLUETOOTH SPEAKER v5.0

Equipped with Bluetooth v5.0 technology, the transmission distance is 33 feet. It can easily connect to cell phones, computers, laptops or your TV.

## ATMOSPHERE LIGHT

Built-in atmosphere lighting provides rich color and ambience.

## PARTITION STORAGE

In order to more effectively utilize the storage space, there are two partitions and one tray in each drawer allowing for more flexible use.

## REMOVABLE DOOR SEAL

The door seal ensures long lasting use of the refrigerated drawers. It is removable so it can be easily cleaned to help reduce energy consumption.

## SHELF STORAGE

Designed with shelf storage to place small items to help personalize your space.

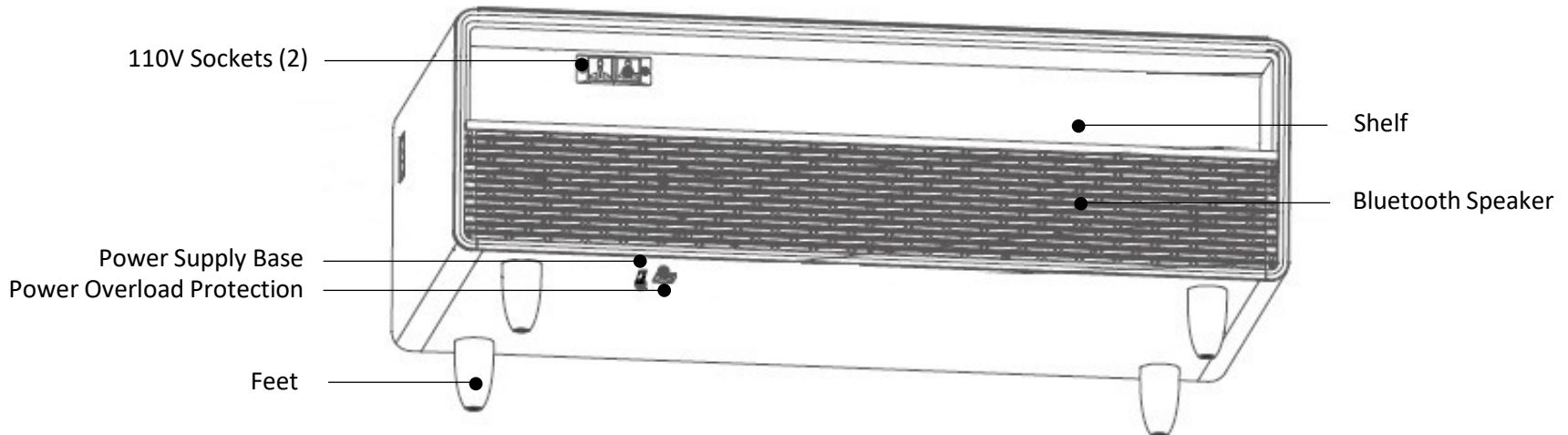
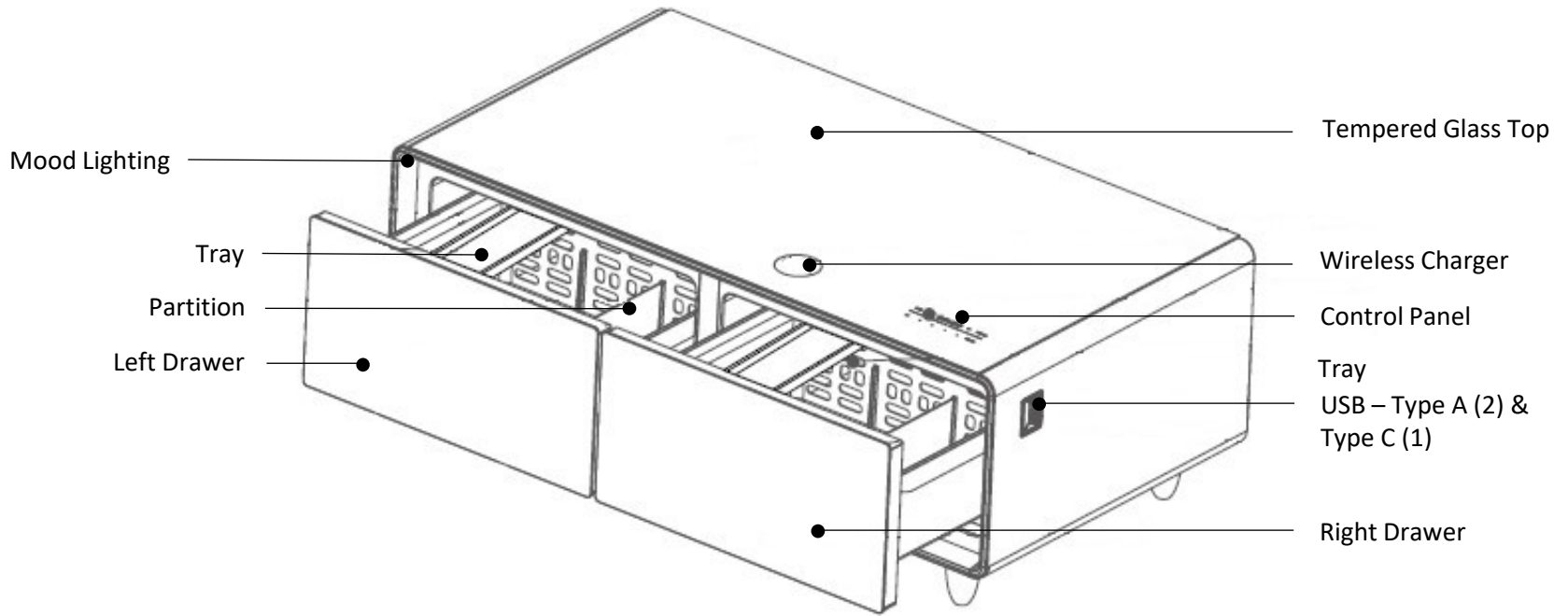

The Control Panel is divided into two sections, split by the horizontal line. The area above the line controls the refrigeration and the area below the line controls the speaker.

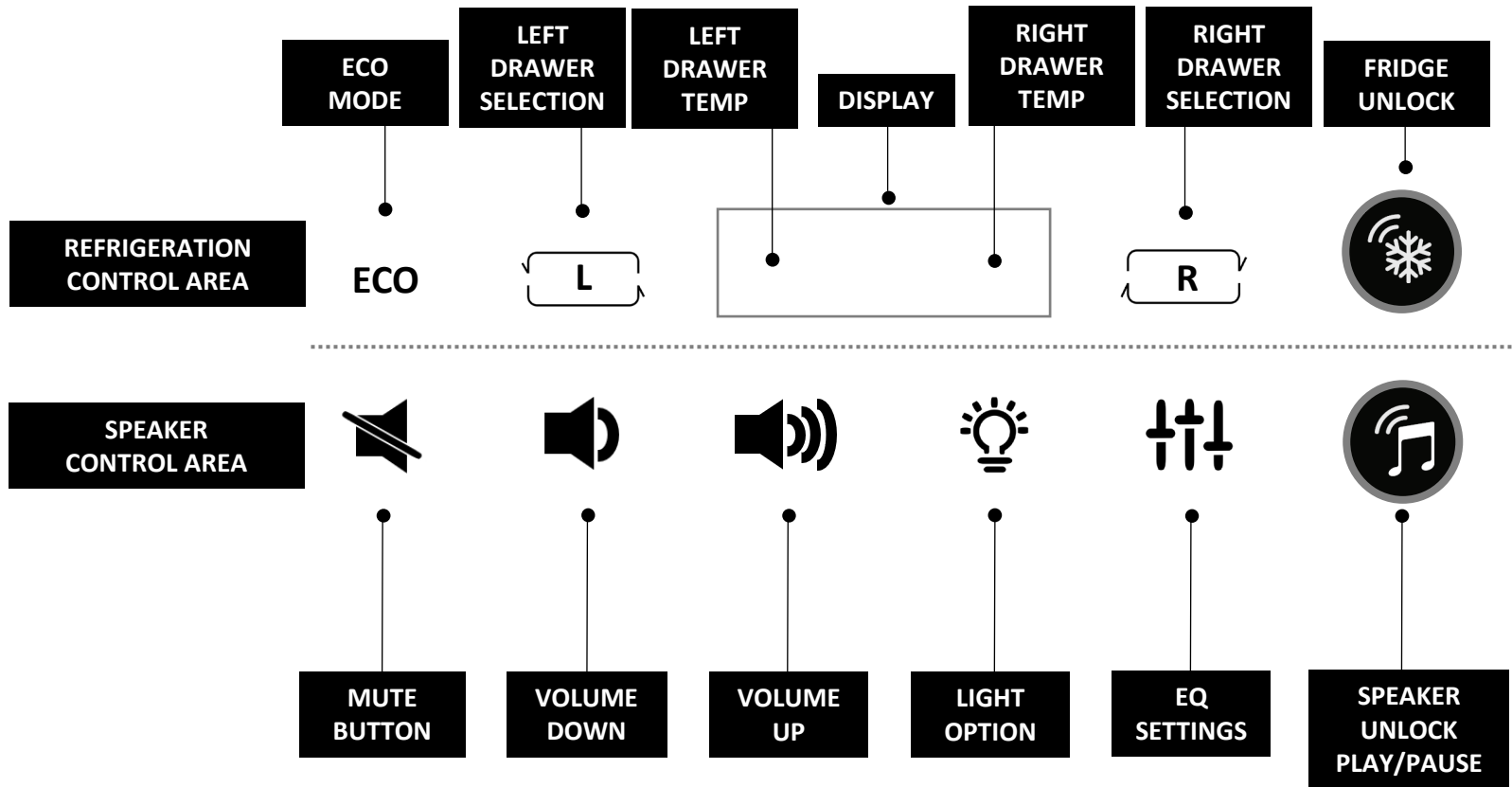

# CONTROL PANEL

## REFRIGERATION CONTROL PANEL

After the initial powering on of the Sound Fridge, it will automatically enter unlock mode. If there is no operation within 10s the control panel will automatically lock.

When control panel is in lock mode, no information will be displayed.

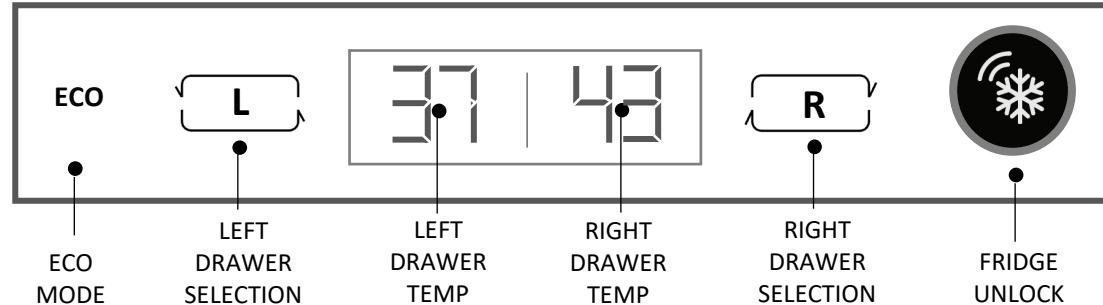

**NOTE:** No buttons can be used in Locked Mode except the Unlock buttons.





## ACCESSING REFRIGERATION SETTINGS

- Double tap on the Fridge Unlock  icon. Current drawer temperatures will appear on the Display.

### LEFT DRAWER ADJUSTMENT

- Double tap on the Fridge Unlock  icon. After unlocking the control panel, tap on Left Drawer  icon.
- Tap on the Left Drawer  icon to until preferred temperature is displayed.

### RIGHT DRAWER ADJUSTMENT

- Double tap on the Fridge Unlock  icon. After unlocking the control panel, tap on Right Drawer  icon.
- Tap on the Right Drawer  icon to until preferred temperature is displayed.

### ECO MODE

- Tap ECO icon. Display will show ECO. This will set both drawers to the most efficient power saving settings.

### DOOR ALARM

- When a Drawer is opened, the temperature of the Drawers will show in the display. If the Drawer is left open, an alarm will beep to remind you to close the Drawer.

### POWER OFF MEMORY



- When the Sound Fridge is powered off, the Power Setting will be memorized and revert back to last setting when powered back on.

## SPEAKER CONTROL PANEL

### ACCESSING SPEAKER SETTINGS

- Double tap on the Speaker Unlock  icon. Speaker will turn on and go into Bluetooth mode.
- On your device, go to Bluetooth settings and select device "SS-FRIDGE". Speaker will announce when device has been paired. Once paired you can utilize the Speaker Control Panel.

### USING THE ATMOSPHERE LIGHT

Press  icon to turn light on. To turn off, press  icon again.

### MUSIC PLAY/PAUSE

Double tap the Speaker Unlock  icon to access the Control Panel, then tap the Speaker Unlock  icon again to Play/Pause music.

### MUTE MUSIC

Double tap the Speaker Unlock  icon to access the Control Panel. Press the Mute  icon. Note: the music will be muted but the song will continue.

### VOLUME ADJUSTMENT

Double tap the Speaker Unlock  icon to access the Control Panel. There are 16 levels of volume.

Tap the Volume Up  icon to increase volume.



Tap the Volume Down  icon to decrease volume.

### LIGHT OPTION

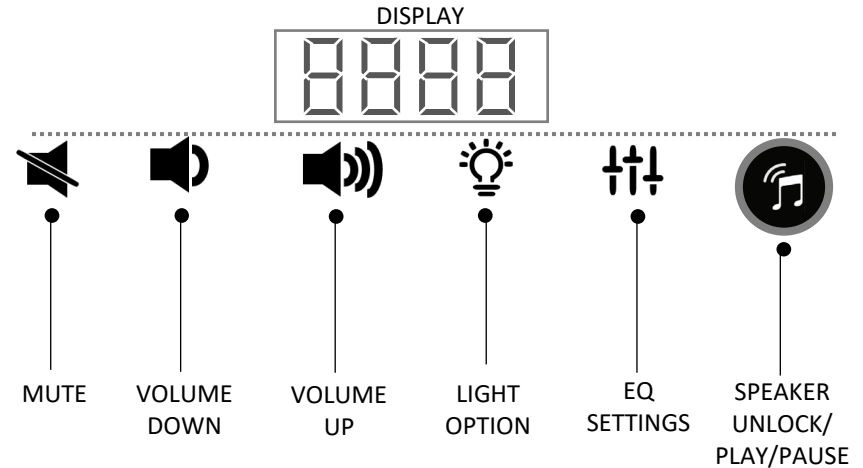
Double tap the Speaker Unlock  icon to access the Control Panel. Press the Light Option  icon to turn light on. Press the Light Option again to turn light off.



### EQ SETTINGS

Double tap the Speaker Unlock  icon to access the Control Panel. Tap the EQ Settings  icon and continuing tapping until desired preset EQ option is displayed on the Display. Preset options include:



AUTO  
FILM  
JAZZ  
POP  
ROCK

**NOTE:** If you have the light option on, depending on which EQ setting you choose, the light effects will change.

### SPEAKER LOCK

If there is no operation within 10 seconds, the Speaker Control Panel will automatically lock.

### SPEAKER OFF

Double click the Speaker Unlock  icon to access the Control Panel. Long press the Speaker Unlock  icon until speaker turns off. Display panel will show OFF.

## WIRELESS CHARGING

NOTE: Wireless charging feature only works for devices that are equipped with wireless charging.

- Wireless charging feature is enabled once the table has been plugged in.
- Try to center device when placing on wireless charger.
- Make sure there is no metal between the charger and the phone to avoid overheating.
- If the charging surface is overheating, remove device from charger.
- Case may need to be removed to utilize wireless charger.
- When using the wireless charger, USB charger should not be used.

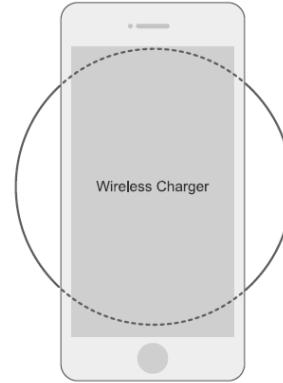

<b>Voltage</b>	12V Input
<b>Output</b>	15W (max)
<b>Sensing Distance</b>	=<10mm
<b>Work Frequency</b>	105-205KHz
<b>Work Temperature</b>	14°F - 149°F
<b>Work Humidity</b>	10%RH - 75%RH

## USB-A or TYPE C CHARGING

There are two USB-A chargers that can connect devices to the speaker and charge device.

There is one Type C charger that can connect devices to the speaker and charge device.

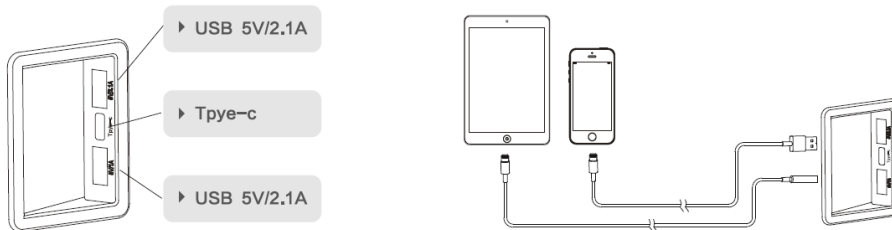

## 110V POWER

There are two 110V sockets to power other devices with a jack current of 10A and a rated power of 2000W. It can meet the power of three pin electrical devices.

- ⚠ Do not drop water in or let water gather in or around sockets.
- ⚠ Do not connect appliances with rated power over 2000W.



## CLEANING THE SOUND FRIDGE

Clean drawers regularly. Do not leave old food stored in drawers.

1. Unplug the Sound Fridge prior to cleaning.
2. Do not disassemble the unit with force, as it may cause damage.
3. Clean the unit with a soft, damp cloth. Dry unit with soft cloth. Do not use too much liquid as it may cause deformation, and or short circuit the unit. No free-flowing liquid should be used.
4. Clean drawers with soft, damp cloth and mild detergent. Dry with soft cloth.
5. Inspect the unit after cleaning. Do not use if any damage is found.
6. Make sure unit is completely dry before plugging back in.

NOTE: Be sure to clean the door seal thoroughly to ensure a long-lasting, good seal and preserve power consumption.

- The Sound Fridge is heavy. Protect floor when cleaning the unit.
- When moving the Sound Fridge, do not shake.
- Do not use hot water to clean glass top or any other part of the Sound Fridge, including the drawers, trays and partitions.

## REMOVING THE DRAWERS FOR CLEANING

1. Before removing the drawers, remove the trays and partitions out.
2. Pull drawer as far as it will go, then lift and pull gently.
3. Clean drawers, trays and partitions can be washed.
4. Clean door seals.
5. Dry all parts before placing the drawers back into the unit.

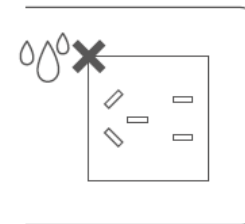
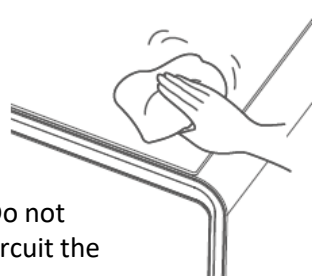

## WARNINGS

Do not spray water onto or into the unit.  
Dry completely before connecting to power source.  
Do not use the following substances:

- Acidic or alkaline solutions or powders
- Benzene, sodium bicarbonate, alcohol, carious acids or petroleum
- Abrasive cleaners
- Abrasive sponges or hard brushes
- Hot water

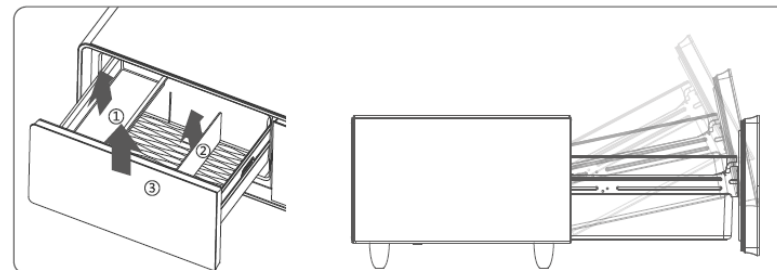

## Transporting the Sound Fridge

Unplug the Sound Fridge.

Secure the trays and partitions.



Do not tilt or stand the Sound Fridge up. The maximum incline should be less than 45-degrees. Inclining more can cause damage to the refrigeration system.

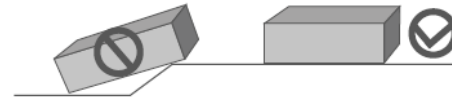
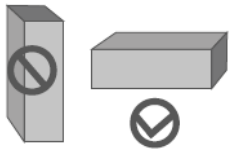

Refrigerated drawers will stay cool for 1-2 hours without power. However, once power has been shut off, do not open the drawers again to preserve the inside temperature.



Any power failure can cause temperatures to rise and shorten lifespan of food and quality of food. If the Sound Fridge has been without power for an extended period of time, unplug the unit and thoroughly clean.



If leaving your home for an extended vacation, please power off if any perishables are being stored in the unit.

# TROUBLE SHOOTING

FAULT	CAUSES	SOLUTION
Power light is on, compressor is working but making buzzing sound.	Power voltage is lower than 187V	local fluctuations exceed 187-242V, it is better to equip an AC-reguatro 2000V.
Compressor starts but stops after one minute, and then starts and stops ongoing.	Power voltage is higher than 242V	
Compressor runs for a long time, but evaporator surface is frost free.	Leak Blockage	Professional inspection required.
There is frost on the surface but the compressor is working.	Too much frost on evaporator	Defrost
	Opening the drawers too much	Do not open drawers as often
	Drawers are too full	Remove some of the items
	Not enough ventilation	Move to a ventilated area
Unit does not work, refrigerator not cooling	Temp setting isn't good or sensor is missing	Professional inspection required.
	Fuse is blown	Replace fuse
Super high pitch noise	Input controlling circuit has fault	Professional inspection required.
	Unit is uneven	Adjust the unit
	Box fastener is loose	Fix the fastener
	Collision between pipes	Separate the pipes

- Condensation on the unit surface: High humidity may cause condensation, use dry cloth to wipe condensation.
- Hissing sound: That is just the sound of the refrigerator.

## LIMITED ONE-YEAR **COSUMER** WARRANTY WITH PROOF OF PURCHASE FROM AUTHORIZED RETAILER

Soundstream promises to the original purchaser, to repair or replace this product with a new or refurbished unit (at Soundstream's sole discretion) should it prove to be defective in workmanship or material under normal use, for a period of one-year from the date of purchase from a Soundstream authorized retailer. During this one-year period, there will be no charge for product repair or replacement, provided the unit is returned to Soundstream, return shipping prepaid, along with the required bill of sale or other dated proof of purchase, and the consumer's contact information.

This warranty is void if any of the following apply:

- (a) Damage caused by accident, abuse, mishandling or transport.
- (b) Units subjected to unauthorized repair.
- (c) Units not used in accordance with instructions.
- (d) Damage exceeding the cost of the product.
- (e) Deterioration of the delivered product resulting from abnormal storage and/or safeguarding conditions on the customer's premises.
- (f) Failure to provide the dated proof of purchase.

By purchasing this product, all warranties including but not limited to express warranty, implied warranty, warranty of merchant ability, fitness for particular purpose, and warranty of non-infringement of intellectual proper are expressly excluded to the maximum extent allowed by law, and Soundstream neither assumes nor authorizes any person to assume for any liability in connection with the sale of the product. Soundstream has absolutely no liability for any and all acts of third parties, including its authorized dealers. By purchasing this product, the consumer agrees and consents that all disputes between consumer and Soundstream shall be resolved in accordance with California Laws in Los Angeles County, California. Some states do not allow a limitation of how long an implied warranty lasts. In such states, the limitation or exclusions of this Limited Warranty may not apply. Some states do not allow the exclusion or limitation of incidental or consequential damages. In such states, the exclusion or limitation of this Limited Warranty may not apply. This Limited Warranty gives you specific legal rights, and you may have other rights which vary from state to state.

Soundstream  
1550 Maple Avenue, Montebello, CA 90640 USA  
[www.epsilonelectronicsinc.com](http://www.epsilonelectronicsinc.com)  
800-832-4647